

The Chronicle

Parish Magazine for Aston Abbotts



No.

135

MARCH 1995

WELCOME to the March Chronicle.

"Editing" has been an interesting and enjoyable experience and thanks to all of those who contributed articles, news etc.

This year we celebrate fifty years of peace, and I'm sure there must be many memories of those days and life as it used to be. In Aston Abbots or elsewhere. If you were a child or adult, here or abroad, how did the war affect you? Why not put your memories onto paper, add a photograph or two, and send it in for one of the next editions of the Chronicle.

Janet Biddle

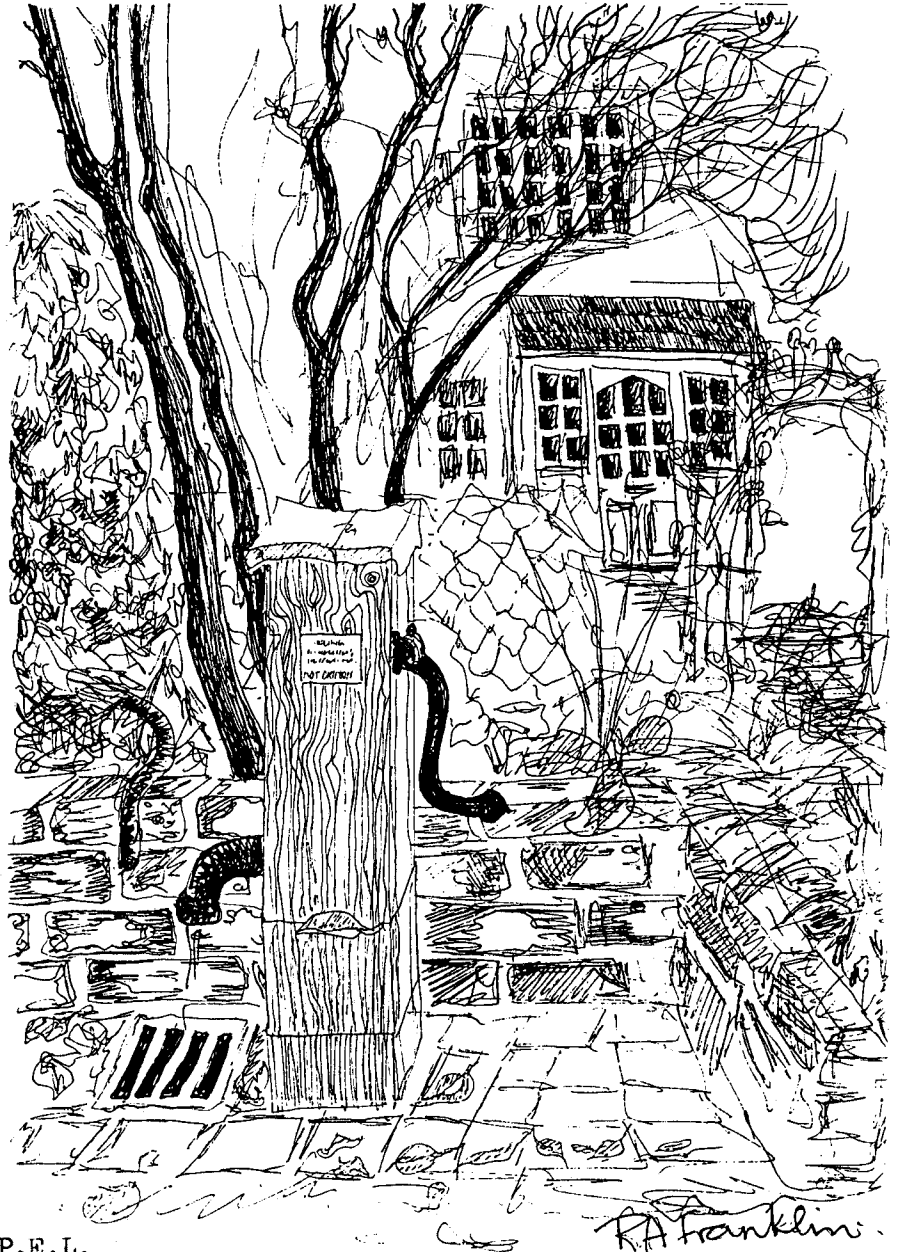

Best Wishes to next months
Editor Margaret Chesher.

Cover- thanks to Sid of S.P.E.L.

Please deliver anything to be included in Aprils issue to 2, Church Row by Friday 17th March.

Published by Janet Biddle.

Printed by Squirrel Press at Waddesdon School.

Distributed free to all households in the parish of Aston Abbots.

What's on

Thursday 9th Bingo Church Room 7.30

Thursdays 2nd/16th/30th Whist Drive Church Room 7.30

Monday 13th Parochial Church Council Meeting AGM
 Church Room 7.30

Sunday 19th Sponsored Treasure Hunt - in aid of Church
 Funds - Meet at the Green 2pm (Forms from Colin)

Tuesday 21st Floral Class Church Room 7.00

Sunday 26th British summer time - Clocks forward 1 hour
 Mothering Sunday
 Deanery Praise Evensong St. James 6.00

Regulars

Tuesdays
Trawler wet fish shop,
The Green, 1.40 - 2.00pm

Mobile Library
See page 12
for full details of
locations and times.

Tuesdays, Thursdays
Butchers van,
about 3-4pm. Will deliver to
door. (0296 75220)

Wednesdays
Bin Day
Toddlers, Church Room
2-4pm.
Fish & Chip van

Bricstock 8pm -ish
Bull & Butcher 8.15 -ish

Fridays
Free bus to Tesco in
Aylesbury, depart from The
Green 10.06am, arrives Tesco
11.01am and back to Aston
Abbotts at about 1.40pm

-BOOK THESE DATES-

Saturday 8th April Jumble Sale Church Room 2pm

Saturday 20th May St Pauls Cathedral & Flower Festival
It is hoped to run a coach for this or
shopping/sightseeing/RNER trip etc.
Entry fee/coach fare to be advised but
about £8. Interested? please call Colin

Saturday/Sunday
22nd/23rd July Festival Weekend

PEOPLE WITH BRIDGET BRANDON.

BIRTHDAYS.

Claire Biddle 8th March
Andy Bystra 8th March
Lydia Smith 15th March
Ann Goodman 15th March
Tracey Fletcher 17th March
George Brandon. 31st March

Would you like your birthday to appear in the Chronicle? Let me know on 681425, and I will see to it. Don't forget, if we don't know, we can't put it in.

GET WELL SOON

George Fox who has had an eye operation.

Bob Higgs who is in hospital.

Barry White who has hurt his knee.



CABARET.

At the time of writing there were a few tickets left for the Cabaret on the 18th March. Priced at £7-50 each, they are available from Chris on 681425. Your ticket buys you a hot meal, a glass of wine, and entertainment that sometimes defies description.



A THANK YOU...

George and Christine Fox wish to say thankyou to everone who asked after George while in hospital and to those who gave transport and help .

DO YOU RECOGNISE THIS WOMAN, LAST SEEN FLYING UP ASTON ABBOTTS HIGH STREET. NAMES TO THE EDITOR PLEASE.



LADIES CLUB for MARCH

MARCH 9th-Spring Lunch Church Room.

I2 for I2.30 till 2.30

Tickets - children £1, members £2

non members £3., available from

members or Shirley Ford 681865

MARCH 23rd- Speaker from Tring Plants and Garden Centre.

CHURCH SERVICES

WINGRAVE	5th Mar	10.0	Parish Communion
		3.0	Annual Church Meeting
	12th	10.0	Parish Communion
	19th	8.0	Holy Communion (BCP)
		10.0	Family Service
	26th	10.0	Parish Communion
	2nd Apr	10.0	Parish Communion

ASTON ABBOTTS	5th Mar	11.15	Morning Service
	12th	11.15	Parish Communion
	19th	11.15	Parish Communion
	26th	6.0	Deanery Praise
	2nd Apr	11.15	Morning Service

CUBLINGTON	5th Mar	10.0	Family Service
	12th	8.45	Parish Communion
		3.0	Holy Baptism
	19th	8.45	Parish Communion
		3.0	Annual Church Meeting
	26th	8.45	Parish Communion
	2nd Apr	10.0	Family Service
		6.0	Evensong

Mid-Week Services:

ASH WEDNESDAY	1st Mar	10.0	Holy Communion (Cublington)
		8.0	Holy Communion (Wingrave)
	8th	10.0	Franciscan Service (Aston Abbotts)
	15th	10.0	Franciscan Service (Rowsham)
	22nd	10.0	Franciscan Service (Wingrave)
	5th Apr	10.0	Holy Communion (Cublington)

SUNDAY READINGS

5th Mar	Lent 1 (p.505)	Heb 2.14-end; Matt 4.1-11
12th	Lent 2 (p.509)	1 John 4.1-16; Luke 19.41-end
19th	Lent 3 (p.514)	Col 1.24-end; Luke 9.18-27
26th	Lent 4 (p.518)	2 Cor 3.4-end; Luke 9.28-36
2nd Apr	Lent 5 (p.523)	Col 2.8-15; John 12.20-32

FROM THE REGISTERS

FUNERALS 16th Feb William Clay (Wingrave & Amersham)

④

WINNERS OF THE FEBRUARY 100 CLUB WERE
 MRS FOX MRS V DUCKWORTH MISS A FORD

RECTOR'S REPORT

Over the last few days I have been trying to think of the way in which I can come to terms with two things that seem to be happening - but so far without success.

More and more people now seem to have and use mobile phones. Personally I quite enjoy being away from the reach of a telephone, but I can see that there may be times when one might be quite useful. I am still linked in to the ordinary, everyday BT network, connected by real wires. Maybe it is the way I have been brought up - but there is the understanding of a tangible link between the two people speaking that I find comforting. It may just be me, but I frequently find it hard to hear what people are saying when they are speaking from a mobile phone. Still, mobile phones we must learn to live with.

For most of my life I have seen television aerials on houses. When I was young many of them seemed to be shaped like an H. Later they became more complex, and now many homes have satellite dishes as well as television and FM aerials. But I read recently that it is hoped that within the next few years every house in the country will have access to cable television. Forget your aerials, we can have better and more sophisticated reception by cable.

Now this seems to me to be rather odd. The telephones are forsaking cable and using aerials (mobile phones use radio waves), whilst the television is forsaking the aerial in favour of cable. It is true that the cable television will use fibre-optic conductors rather than conventional 'wire', and that this will, they assure us, enable many more signals to be transmitted more efficiently.

But what does it mean? So far the only 'meaning' that has come to me is that it is going to become even harder to be alone with ourselves. We shall not have the opportunity to be still with our thoughts because we shall be constantly bombarded with messages. Maybe that is because we find it hard now to cope with silence and stillness. We want to fill every silence with noise. It doesn't matter too much what the noise is, or where it comes from, so long as it stops the silence.

Perhaps during Lent we should switch off the noise and - "Be still and know that I am God".

Bob Willmott

WHATS HAPPENING AT ST. JAMES

At the January Church Council Meeting it was agreed to accept a quote of £1700 for electrically winding the clock, which of course means fund raising. However so as to make the fund raising more fun and seem less like taking your money, the members of the P.C.C. decided on some new ideas, and hope you will join us for some if not all, so please book these dates.

SUNDAY 19th MARCH - Sponsored Treasure Hunt
Commencing at 2pm from the green.

SATURDAY 8th APRIL - Jumble Sale in Church Room 2pm.

SATURDAY 13th MAY - Barbers Shop Concert & Buffet Supper
St. James 7.30pm.

SUNDAY 18th JUNE - Gardens Open Day/Teas

SATURDAY/SUNDAY - ST. James Festival Weekend (flower theme Wedding Anniversaries)
22nd/23rd JULY

We have also been left some money by the late Miss Betty Bennett to purchase new alter frontals, and we are collecting TARGET STAMPS from the Leighton Buzzard Observer towards the cost of repairing the Church porch. The holly hedge has now been cut, and the ditch cleared back which allows the compost bins to be resited to alleviate problems to the Old Masters and to drainage in the churchyard to graves area.

Colin

For Information Local Police Details

P.C. Mick Griggs,
your local Police
Officer now has
his office at;



**THAMES VALLEY
POLICE**

Charlotte Cottage, Leighton Road,
Leighton Buzzard, Beds. LU7 ONN

Tel. (0296) 396163 or 396164
Fax. (0296) 682230

This office will not always be manned; for an
immediate response please telephone;-
(0296) 396000

CAN YOU SPEAK FOR SOMEONE IN NEED OF HELP?

Aylesbury Vale Advocates (AVA) is a local charity which has been working throughout Aylesbury Vale for four years.

AVA helps people with communication difficulties which prevent them from voicing their own needs. These difficulties may arise from a variety of causes, learning or physical disability, or old age.

AVA volunteers get to know their clients well so they can then speak out or write on their behalf when need arises - for example to agencies like the local council, health authority and social security. Help has also been given by volunteers in arranging holidays, obtaining advice about benefits, personal budgeting, making appointments and attending meetings with solicitors, doctors and social workers, finding accommodation and dealing with correspondence.

Volunteers are fully supported by the AVA Coordinator, a qualified counsellor, who offers advice and training. Out of pocket expenses are paid.

If you have a caring nature and a couple of hours to spare a week, you can apply to become a volunteer. To find out more about our work, please contact:-

THE COORDINATOR
AYLESBURY VALE ADVOCATES
7, TEMPLE STREET
AYLESBURY
HP20 2QA

TEL: 0296 432313

CHARITY REGISTRATION NO. 802724

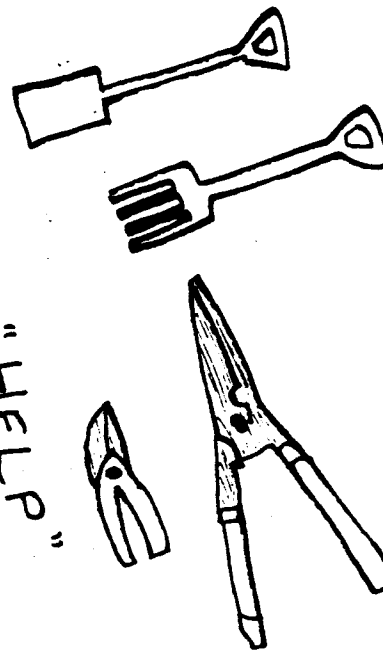

DO YOU NEED
WITH YOUR GARDEN?

"HELP"

Pruning Strimming
Hedge-cutting Weeding etc.

Experienced in all garden
maintenance. No job too small.

Reasonable rates

CALL ALAN KEMPSTER
(0296) 681310

BED & BREAKFAST

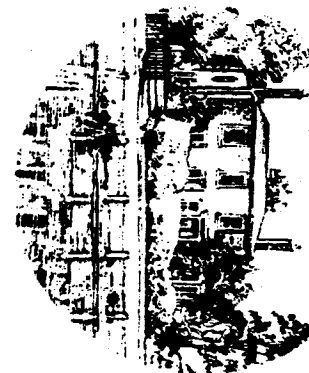

JEAN KEIGHLEY

THE OLD VICARAGE
LEIGHTON ROAD, WINGRAVE
AYLESBURY, BUCKS HP224PA



TELEPHONE
(0296) 681 235

TO IVOR CHEEK

The elegant yet assured handwriting, the brown envelope, the mysterious postmark... and an Editor's heart skips a beat. Yes it's another item from Ivor. Unfortunately, out of consideration for (a) those of a sensitive nature (b) those of pure heart and charitable mind, and (c) grown-ups, it was not deemed possible to print your 1994 Village Round-up. I must not keep this to myself though - so anyone who does not fall into one of the above categories can get a (typed) copy from me!

Caroline

**WADDESDON CHURCH OF ENGLAND
SCHOOL.**

**SIXTH FORM.
OPEN EVENING 29TH MARCH.
7.30 pm.**

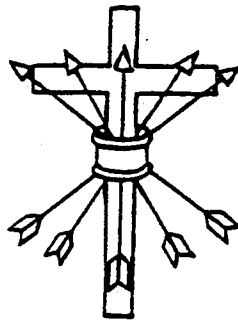

We welcome students from other schools and adults returning to study. Waddesdon offers a wide range of A level and GNVQ courses.

For further details, or an opportunity to visit us and talk about the courses, please contact Graham Parker at

Waddesdon C of E School,
School Lane,
BUCKS. HP18 0LQ.
0296 651382.



THAMES VALLEY POLICE
SPECIAL CONSTABULARY.

The Thames Valley Police has an establishment of over 1000 Special Constables and at present requires a number of suitable people to make up the strength. We have a tremendous job to do and we are stretched to the limit in doing it. Today, more than ever, we need everyone's help. Why not yours in the most direct and practical way of all- by joining us as a Special Constable.

Training is done at your local Police Station. You will learn how the Police Force is organised and how various parts of it dovetail together. You will be taught Police powers of arrest and given an insite into the Criminal Law. You will learn about traffic law and local by-laws.

We now have a Special Constabulary Rural Section based locally at Wing police office. Once your training is completed you could volunteer to join us and be made responsible for policing your own village.

So by now the question you may be asking yourself is am I eligible to join,. Well applicants must be of British nationality, be of good character, physicaly fit and between 18½ and 50 years of age. We have no minimum height stipulation. For further infomation about joining please contact one of following :-

Sergeant David OWENS. Wing Police Office Tel N° 0296 396163.
Section Officer Tony SAUNDERS (Specials) Home Tel N° 0296 66800

Sergeant David OWENS.
Rural Police Office.



The Bull & Butcher

Presents

F E B R U A R Y

SATURDAY 18th

CHINA ROSE

SATURDAY 25th

SELECT SOUNDS DISCO

Frank & Louise's **FOURTH** year at

The Bull & Butcher

M A R C H

FRIDAY 3rd

THE BROCH BAND

FRIDAY 10th

CLASSIC

FRIDAY 17th

St. PATRICK'S NIGHT

BREEZE

Traditional Irish Folk Band

FRIDAY 24th

GOOBERHEADS

A P R I L

SATURDAY 8th

AURA



The Bull & Butcher

Presents

Friday 17th March

AN EVENING OF IRISH CULTURE

St. PATRICK'S NIGHT

Live Music

9pm - 11pm

Traditional Irish Fayre

From 7 - 9pm. Book Early

Home Made Soup
Boiled Bacon & Cabbage

Served With
Potatoes & Onion Sauce
Sherry Trifle

£8.50 per Head

Guinness & Caffrey's
£1.20 per Pint

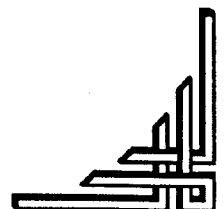
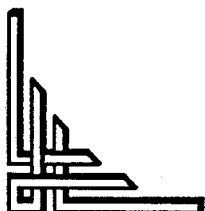

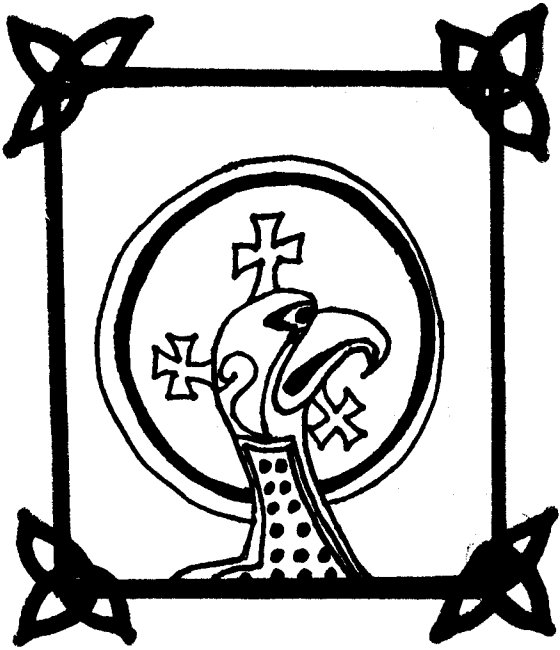

A traditional Irish song to celebrate St. Patrick's day on March 17th.

Oh, St. Patrick was a gentleman, who came of decent people,
He built a church in Dublin town, and on it put a steeple.
His father was a Gallagher, His mother was a Brady,
His aunt was an O'Shaughnessy, his uncle was an O'Grady.

The Wicklow hills are very high, and so's the Hill of Howth sir,
But there's a hill much bigger still, Much bigger nor them both sir,
Twas on top of this high hill St. Patrick preached his sarmint
That drove the frogs in the bogs, and banished all the varmint.

There's not a mile in Ireland's isle where dirty varmint musters,
But there he put his dear forefoot, And murdered them in dusters,
The toads went pop, the frogs went hop, slap dash into the water,
And the snakes committed suicide to save themselves from slaughter.

So success attend St. Patrick's fist, for he's a Saint so clever,
Oh he gave the snakes and toads a twist and banished them for ever.

.....

And talking of toads.....!

We are approaching the time of year when the toads cross the road
between Windmill Hill Farm and the Abbey, most go over when its dark
so drive with care, or go on foot with torch, bucket and rubber gloves
and help them across in person.

.....

2 The ingenious milkman

A milkman has only a 5 pint jug and a 3 pint jug to measure
out milk for his customers from a milk churn.

How can he measure 1 pint without wasting any milk?

Answer pg. 22



THE CHRONICLE
Advertising rates for 1995

All rates quoted are per annum

FULL PAGE Back £65
 Inside £33

HALF PAGE Back £33
 Inside £16

QUARTER PAGE Back £16
 Inside £9

EIGHTH PAGE Back £9
 Inside £7

OTHER ADS. Inside £7

Please send copy and cheque
(made payable to "The Chronicle")
to John Whyte, 14, Bricstock,
Aston Abbots, Aylesbury,
Bucks.
Tel. 0296 681685

HELP LINE

(Driving you to the doctor,
picking up prescription and so on)

CHRIS BRANDON
12 Bricstock, 681425

MARGARET CHESHER
20 The Green, 681201

JOHN FORD
2 Ross Road, 681865

ROY MALIN
3 Ross Road, 681358

JOHN WHYTE
14 Bricstock, 681685

GEORGE FOX
1 Church Row, 682024

YOUR PARISH COUNCIL

ROGER BIDDLE
1 Firs Cottage, Wingrave Road 681102

JOHN FORD
2 Ross Road, 681865

CAROLINE LANE (Chairman)
2 Church Row, 681373

ROY MALIN
3 Ross Road, 681358

VICTOR SCOTT
11 The Green, 681488

CLERK

ROBERT LEE 4 Ross Road 681558

District Councillor
BRYAN ROUND
11 Nup End, Wingrave, 681621

County Councillor
BRENDA JENNINGS
2 Cotes Way, Wing 681065

**THE MACINTYRE
RECYCLING CENTRE**

The Centre will have the following
collection containers

GLASS Please separate green,
 brown and clear glass
CANS All types of cans
 including steel
 and aluminium food and
 drink cans

PLEASE CRUSH YOUR CANS

PAPER All newspaper and
 magazine wastes
 (Office waste paper can
 be recycled together
 with small quantities of
 directories.)

NO CARDBOARD PLEASE

TEXTILES All old clothes, rags,
 blankets

THE CENTRE IS OPEN FROM
8.30 am TO 6.30 pm
MONDAY TO SATURDAY



Spanish, English & Continental Cuisine

Lunch: 12.00 noon - 2.00 p.m.

Dinner: 7.00 p.m. - 10.00 p.m.

Closed all day Sunday and for Monday lunch

SPECIAL MENU - 3 courses £10

available for lunch Tues - Sat
and dinner Mon - Thurs 7.00 - 8.00 p.m.

The Old Masters Restaurant
Cublington Road, Aston Abbots, Bucks
Tel: Aylesbury (0296) 681432

FULLY LICENSED

FIELDFARE ORGANICS

(FOOD YOU CAN TRUST)

4 reasons why you should
consider buying ORGANIC.....

Organic food,

* TASTES BETTER

* Contains no harmful chemicals

* Is a green choice, you won't
be contributing to chemical
pollution if you buy organic

* Helps sustain health and prevent
illness....."Let food be your
medicine" (Hippocrates)

**** WEEKLY ORDERS TAKEN ****
FRUIT & VEGETABLES

For further details contact....

Sheila Featherstone 0296 681292

Rita Jones 0296 681850

HELP REQUIRED

WITH CLEANING AND GENERAL
HOUSEWORK.

3 HOURS PER WEEK IN SMALL
COTTAGE IN ASTON ABBOTTS.

GOOD RATE OF PAY

PLEASE PHONE JO-ANNE WRIGHT
688693

NEED A HAIR CUT?

Then contact

DONNA
688597

GENTS

Wet Cut £4.00

Cut/Blow Dry £5.00

LADIES

Wet Cut £6.00

Cut/Blow Dry £8.00

Blow Dry £4.50

Perm £15.00

All in the comfort
of your own home

Recipes

Simnel Cake *for Mothering Sunday*

6 oz butter, 6 oz caster sugar, 3 size 1 eggs, beaten, 6 oz currants, 8 oz sultanas, 2 oz glace cherries, grated rinds of 1 small orange & 1 small lemon, 2 oz chopped candied peel, 8 oz plain flour, 1 level teasp baking powder, 1 level teasp mixed spice, 3 tablesps milk

For topping and filling: 12 oz ground almonds, 12 oz sieved icing sugar, 3 size 1 egg yolks, 2 teasp lemon juice, 1 teasp almond essence, 1 tablesp brandy or sherry, 1 dessertsp apricot jam, small egg beaten

Line and grease one 8 inch cake tin. Cream the butter and then add the sugar and beat until light and fluffy. Add the beaten eggs, a little at a time. Gently fold in the fruit, candied peel and orange and lemon rinds. Sift the flour, baking powder and mixed spice and then carefully fold it into the mixture alternately with the milk. Fold gently - do not beat. Spoon half the cake mixture into the prepared tin. For the Almond paste: Combine 12 oz of ground almonds with 12 oz sieved icing sugar. Mix the three egg yolks with the lemon juice and almond essence. Stir this into the almonds and icing sugar and knead to a stiff paste, add the sherry or brandy. Now take one third of the almond paste, and roll it out to form a round approx 8 inches in diameter. Fit the circle of almond paste over the cake mixture, laying it gently, then spoon the rest of the mixture over it. Level it out, then bake the cake in the centre of the oven for about 2½-3 hours, gas mark 2 (300F, 150C), or until the centre is firm and springy.

Leave the cake in the tin to cool for 15 minutes, then turn out on to a wire rack to cool. When cool brush top with a little warmed jam. Roll out half the remaining almond paste to fit the top of the cake. Press securely all round. Make twelve little balls of almond paste from the rest (to represent the twelve apostles). Brush the top of the cake with beaten egg, fix the "apostles" all round, pressing them gently and brush them with beaten egg too. Place the cake under a hot grill until the almond paste turns a golden colour.

Mothering Sunday and its Origins

Mothering Sunday, which provides a welcome 'time off' from Lent, brings together a glorious array of traditions. Its roots lie in ancient Rome, its customs belong to 18th century Britain and its commercial success it due largely to the American armed forces.

The Romans honoured their goddess of motherhood in Spring with the feast of Matronalia. Cakes made of special extra-fine flour known as simila were baked and offered to her. When the Church became established in Britain Christians incorporated these customs, but instead of celebrating Matronalia they honoured Mother Church.

It is unclear when the honouring of Mother Church was extended to include thanksgiving for our own mothers. During the 18th and 19th centuries Mothering Sunday was a day when domestic servants were given time off to visit their own homes and mothers. They would often take special presents including a Simnel cake. The Simnel cake may own its name to the white floured cakes offered at Matronalia.

Mother's Day arrived in England when the American armed forces were based here during World War II. They brought with them their May customs of honouring their mothers with gifts of cards, flowers and sweets. Today Mothering Sunday and Mother's Day are celebrated on the fourth Sunday of Lent. Mothering Sunday is also sometimes called Refreshment Sunday, or Laetare Sunday, traditionally a day when the fasting rules of Lent are relaxed.

Throughout history Mothering Sunday has been a remarkably adaptable festival. Its themes of mothering, caring and giving thanks are universal. Today some churches concentrate on the concept of 'mothering' and instead of focusing only on Mother Church and our own mothers, emphasise the 'mothering' everyone does at home or in the community.

This Mothering Sunday why not go to Church as a family? Perhaps visit the Church where your parents were married or where the children were baptised.

(Skilled Friendly Service)

S.M. ARMAN.



BUILDING & LANDSCAPING

- **PATIOS & LANDSCAPING**
- **PATHS & DRIVEWAYS**
- **TURFING & PLANTING**
- **EXTENSIONS**
- **REFURBISHMENTS**

***To discuss your requirements
and supply FREE***



***no obligation quotation
please telephone:***

Aylesbury (0296) 682054

A FLORAL FROLIC IN AID OF CANCER RESEARCH

If you enjoy working out the clues to crosswords here is a fun competition for you to enter. The answers are all flower names - although you don't need to be a gardener to work out the answers, ie. no. 14. A bovine error ... COWSLIP! Or just fill it in for your own enjoyment.

1. I lift Larry in a disturbed state (10)
2. Can be seen in dismal lowlands (6)
3. Transport before the race (9)
4. Releases one article (7)
5. Many sided with you and me (5)
6. Is within twenty-four hours (5)
7. Photograph the monster? (10)
8. Laze about in motoring organisation (6)
9. Remember me in the middle (6-2-3)
10. Uncertain whether it will bloom (9)
11. A depressed subject of campanology (8)
12. Sounds as though Cynthia's gone up in the world (8)
13. ...but Cilla gets upset (5)
14. A bovine error (7)
15. Mans best friend got up (3-4)
16. Unwell, we hear, the French males(8)
17. Can only watch the dancers? (10)
18. Warm up the lady! (7)
19. A vessel for the goat (9)
20. Avalanche? (8)
21. Minor chiding includes this (6)
22. Haste is fine (9)
23. "The way to the everlasting bonfire" (Shakespeare) (8)
24. Named after the sin of sloth, apparently (9)
25. Monet's pen writes differently (9)

- 26. Endless mural in reverse (4)
- 27. He loved his own reflection and pined away (9)
- 28. Polly in new kimono, initially (4)
- 29. British Explorer has first class return (7)
- 30. Girl Painter has money at heart (8)
- 31. Wine puts on weight, starting early (7)
- 32. I set a pot in confusion (10)
- 33. Sound of sheep (5)
- 34. Searing card game (3-3,5)
- 35. No 1 returns after bivouac (7)
- 36. Know of old the song (8)
- 37. Sweet young thing is fed (11)
- 38. Oriental form of illumination (7,7)
- 39. Acts as sweeper (5)
- 40. ...but no score in the fog (4-2-3-4)

To enter send completed answers - with your name and tel no. and £1 (or more if you wish, all monies to Cancer Research Campaign) by 29th March to Janet Biddle, 1 Firs Cottage, Wingrave Rd. or Caroline Lane, 2 Church Row. Answers in April's Chronicle. Prize is a bottle of wine.

.....and something else to set you thinking.....

1. The square, cross and circle

Three holes are cut in a sheet of metal as shown.
 How could one block of wood be cut which could pass through each hole and fit them each exactly?

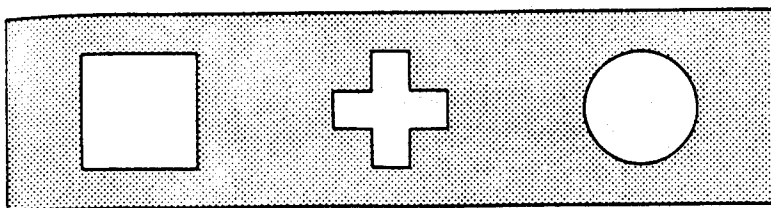

answers page 22



THE FIVE ELMS

IT'S.....COMPETITION TIME at the FIVE ELMS

FREE bottle of WINE with your MEAL, to the FIRST TWO with the CORRECT ANSWERS to the following :-

A. In which film are these characters -

- 1. Lenny The Dip**
- 2. Strangeways**
- 3. Soapy Stevens**

B. From which film are these lines taken :

OS : I called Mama, she was so happy, she cried. She wants you to have her wedding gown it's white lace.

JE : Os, I can't get married in your mother's dress... she and I, we're not built the same way.

OS : We can have it altered.

JE : Oh no you don't. Os, I'm going to level with you. We can't get married at all.

OS : Why not ?

JE : Well, in the first place, I'm not a natural blonde.

OS : Doesn't matter !

JE : I smoke, I smoke all the time.

OS : I don't care.

JE : I have a terrible past. For three years now I've been living with a saxophone player.

OS : I forgive you.

JE : I can never have children.

OS : We can adopt some.

JE (exasperated) : But you don't understand Os, I'm a man !

OS : (entirely unfazed) : Well, nobody's perfect !

Answers on a postcard please...or... you can always drop down to the pub !!

The competition is not open to relatives or employees of the FIVE ELMS, or its antecedents, roots or any other branch of the family, do you twig ? or does it leaf you cold ?

Absolutely no barking up the wrong tree !!



THE FIVE ELMS

Bring your CHUMS in for a PEDIGREE and go GREENE with a KING and ECCLESIASTICAL with an ABBOT.

MAD MARCH HARE WEEK commences with ~

LIVER & BACON EVENING

MONDAY 13th MARCH

Our own S & K Pudding Chef brings you another good old traditional English experience.

*Live...er little !!! Large portions doled out, taste the meat that can't be beat !!
7.30 onwards Please Book*

The ultimate give away ! while stocks last, to commemorate Mad March Hare Week we will GIVE AWAY with every evening meal, commencing Monday March 13th, wait for it ... A SACHET OF HAIR SHAMPOO / CONDITIONER. Is this your own hare or a wig sir ?? yes you too can rabbit on at the FIVE ELMS, just pelt down here fur a great evening.

.....ANOTHER HARE BRAINED IDEA FROM THOSE PEOPLE AT :

UNDOUBTEDLY THE MOST HAIR RAISING PUB IN WEEDON

TUESDAY / SUNDAY EVENINGS

TAKEAWAY NIGHTS

As we are not available to cook for you on these nights, WHY NOT order a takeaway and eat it on the premises ?? Various Indian / Chinese Menus available from behind the bar.

RING YOUR ORDER THRU' FROM THE PUB

Yet another good idea from the 'Pedigree' stable that bred the winning line of

CURRY NIGHTS I - V, and soon to be conceived ...

CURRY NIGHT VI

LUNCHES SERVED

7 DAYS A WEEK

EVENING MEALS EVERY NIGHT EXCEPT TUESDAYS & SUNDAYS

"STUPID BOY"

641439

Aston Abbotts



Usually Resident Population

(DISTRICT)

Total population	340	145,873
Male	172	72,360
Female	168	73,513
In private households	340	142,579
In communal/residential establishments	0	3,294

Characteristics of Usually Resident Population (%)

Aged under 16	22.41	21.22
Over retirement age	17.99	14.45
Economically active	66.79	68.22
Unemployed	4.57	5.84
(Included in economically active)		
Retired	14.71	11.08
Non-white ethnic group	2.06	3.95
With limiting long term illness	9.71	9.04
Moved in previous 12 months	9.71	11.31

Households and Dwellings

Total households	129	54,810
Total dwellings	137	57,356
Dwellings with Residents	130	54,549
Average household Size	2.62	2.61

Characteristics of Usually Resident Households (%)

Owner-occupiers	69.53	72.43
Rented from Local Authority	19.38	17.29
Rented from Housing Association	0.00	0.93
Without central heating	10.85	5.90
With no car	17.83	18.55
With 2 or more cars	46.51	38.93
With more than 1 person/room	0.77	1.37
Lone parent household	0.77	2.59
Containing pensioner(s) only	23.85	19.51

Produced by *Richard Wells*
 INFORMATION SECTION
 Forward Planning Division,
 Planning & Building Control Dept.
 Exchange Street, Aylesbury,
 Buckinghamshire, HP20 1BU

tel. 0296 555438

CHILD'S PLAY

Oh, what a busy morning, I've been playing with the dough
And with a little help, upon a card I learned to sew.
I helped my friend "Nurse Sarah" to perform an operation,
Then I fixed the track together for my train and built the station

I popped inside the Wendy house to make a cup of tea
And I stopped beside the cooker making lunch for twenty three.
I completed three whole jigsaws and played a new board game
And had a turn on all the bikes, the slide and climbing frame.

I handed round the biscuits at milk and biscuit time,
Then I listened to the story and sang some nursery rhymes.
But now the mornings over and the Mummies are waiting
I hope my Mummy doesn't say "I wish you'd done a painting".

WINGRAVE PLAYGROUP

Wingrave Playgroup is held Monday to Friday from 9.30 to 11.45 a.m.
at the Community Centre, Wingrave. There are currently vacancies for
children from 3 to school age. Parents are welcome to look round
before booking a place. For further information contact Dee Whyte
681685.

ASTON ABBOTTS YOUTH CLUB

Having been involved for a while with the village youth club until
its demise in 1987, I have recently discovered that there is a
National Savings Account for this club which is gathering dust and
interest, and amounts to over £222. This money could be used to
help restart the village youth club if anyone was interested and
willing to organise it.

Please contact me if you are interested or have any comments as to
the possible use of this money. if no interest is shown, I will
arrange to transfer the money to the village fund.

Richard Plested tel 681740

Answers

Activity 2

First fill the 3 pt jug. Next pour the 3 pints from this jug
into the 5 pt jug. Again fill the 3 pt jug and then pour from
it into the partially filled 5 pt jug until it is full. This leaves
exactly 1 pint in the 3 pt jug.

It would thus be possible to measure any whole number of
pints by measuring single pints in this way. Clearly there are
more efficient ways for measuring most quantities. 5 pints and
3 pints can be measured directly and as $6 = 3 + 3$ while $8 =$
 $5 + 3$, 6 pints and 8 pints are easily measured. But what about
7 pints and 4 pints?

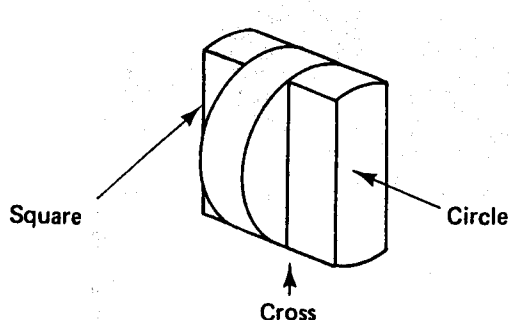

THE SMALL FIRMS COMPUTER ADVISOR

**CHURCH FARM COTTAGE
ASTON ABBOTTS
AYLESBURY
BUCKS HP22 4NB
tel: 0296-681092**

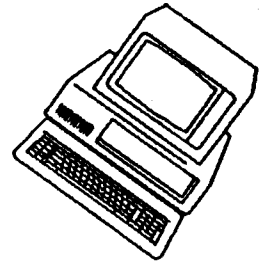

Provides assistance to both new and existing computer users in the following areas:

- i) Choosing hardware and software.*
- ii) Installation, Training and Guidebooks.*
- ii) Friendly after sales service and support.*

LAWNMOWERS GARDEN MACHINERY, ATV's SALES, SERVICE, REPAIRS

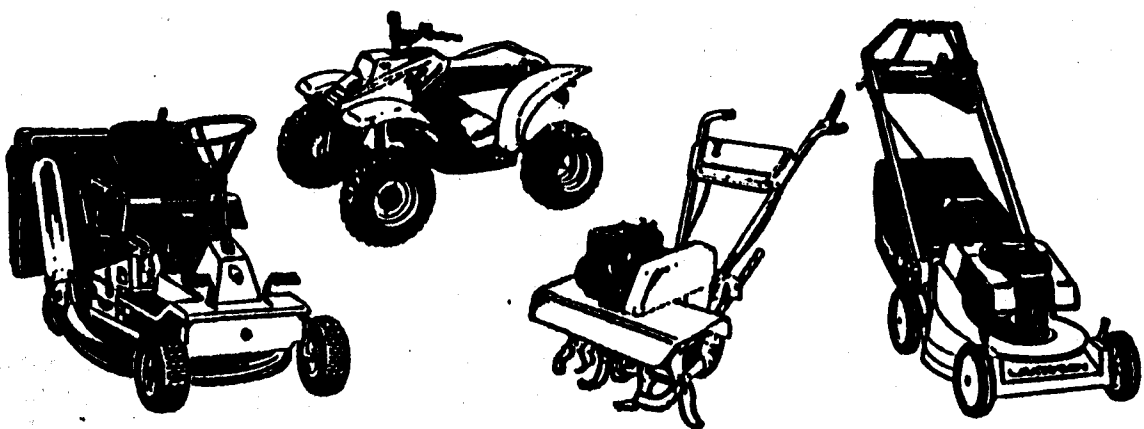

FREE LOCAL COLLECTION & DELIVERY SERVICE

RGC MACHINERY, WING

TEL: (0296) 681007 or (0296) 681286

PARISH COUNCIL

Unofficial notes from the parish council meeting on 3rd February.

Goodbye Margaret! who has resigned as Clerk. She was thanked for her five+ years' hard work for the village.

Matters arising: Bucks County Council offered to lower the new sign opposite the shop to 2m (i.e. not much but better than nothing).

Long discussion about poor state of roads (mud, potholes) and verges in the village (PC Griggs and County Cllr Jennings also present and contributed to discussion). Agreed to ask a rep from BCC to visit with Cllr Jennings and Caroline and see what could be done about maintenance. Parish Council heard about steps taken by contractors at Oxley's Farm to clean road regularly and concluded little more to be done. Clerk would write to owner of land off Wingrave Road where turf cutting is contributing to mud problem.

PC Griggs reported that there had been few problems in the village recently but encouraged residents to report anything suspicious.

Planning applications: Wall at the Abbey granted by AVDC subject to keeping the hedge and putting in pipes for toads.

No comment from PC on rebuilding of stable block at Lower Burston Farm, together with alteration to internal staircase and addition of two dormer windows.

No comment from PC on single-storey extension at 1 New Zealand Cottages.

PC concerned about application to store six earthmoving vehicles at farm buildings on Wingrave Road - requested info about number of likely movements, particularly through village

The Parish Council had applied for permission to prune two trees on the Green (those obscuring the white light). *Please note the Clerk has a copy of all planning applications and you can ask to see them - saves travelling into Aylesbury*

Accounts: Electricity, £23.76; street light repairs, £65.34 and £48.29; new sign for Rec. gate, £23

AOB: Caroline would reply to BCC about cycle routes and tell them we would be willing to distribute questionnaires.

Quotes would be sought for mowing the Rec.

Members of the public complained that despite the dog mess bin on the Rec., dog mess was still a problem. Please use the bin if your dog fouls the Rec. You can even get a free scoop from the Clerk.

New Clerk: Robert Lee is the new Parish Council Clerk: 4 Ross Road, tel. 681558. All good wishes to him.

*Next meeting: Friday 17 March, 8pm, Church Room

*Preceded by Annual Parish Meeting, 7.30pm ALL WELCOME

Parish Council Elections If you would like to be a parish councillor - elections are in early May. Nomination papers (to be in by 4 April)*will be available from the Clerk sometime in March - look out for notices. The PC gets asked about anything and everything from (yes) dog mess to the County's transport policy; some of it can be very interesting, and all of it affects people in this village. Don't be shy!

* I think -
check
notice!

ANNUAL PARISH MEETING

The Annual Parish Meeting will take place on Friday 17 March at 7.30p.m.

This meeting is independent of the Parish Council, and provides an opportunity for villagers to get together to discuss village issues. Its main business is usually the village fete - electing the committee and deciding on a share of the proceeds. If you are interested in helping with the fete and want to know more about what is involved do please come to the Annual Parish Meeting.

The Meeting also hears reports from the Church Room Management Committee, the Recreation Ground Committee and The Chronicle.

Villagers are welcome to put items on the agenda. If you wish to do so, please contact Gordon Smith, the Clerk to the Meeting - 2 Church Row, or 681373.

top Press - Stop Press - Stop Press - Stop Pres

Aston Abbotts once again has its own 'Bucks Herald' Correspondent

The Bucks Herald	
Aston Abbotts	
	<u>Correspondent:</u> Robert Lee Tel: 681558

So, if you see an older version of this man, tell him about your forthcoming community events and any local news which might be of interest to a wider public; then watch the Community Life pages of 'The Bucks Herald'.

Wingrave Garage

Terry Bracey Wright & Michael Mitchell

Wingrave
Aylesbury
Bucks. HP22 4PD
Aylesbury 681543

Free Courtesy Cars



Credit Cards Now Accepted

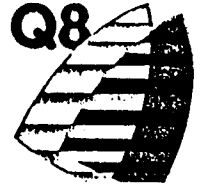

Unleaded

Any make of car serviced • Sun tester tuning • Chassis welding • Sill repairs



The ROYAL OAK

- * Real ales
- * Bar billiards
- * Darts
- * Good home cooked food 7 days a week
- * Kids' drinks: buy one and get the refills free



Special events

Ring for
more details, 681262

ENCLOSED GARDENS & PLAY AREA
CHILDREN WELCOME

LONGMOOR FARM

*Cublington Road
Aston Abbots
Buckinghamshire
HP22 4ND
Tel: 01296 681010*

Mr. and Mrs. J. Sansome



*Bed and Breakfast amidst delightful rural surroundings only five miles from Aylesbury
and Leighton Buzzard.*

AYLESBURY RURAL MOBILE LIBRARY

Route 2a Calling on alternate Tuesdays as follows;-

*Aston Abbots	Wingrave Rd.	9.30 - 9.45
*Aston Abbots	The Green	9.50 - 10.20
*Wingrave	Abbotts way	10.30 - 11.00
*Wingrave	The Bell	11.05 - 11.25
*Wingrave	The Green	11.30 - 11.55
Bierton	Parsons Lane	12.10 - 12.40
Wing	OAP Home	2.00 - 2.15
Cublington	Unicorn Inn	2.30 - 2.55
Weedon	East End	3.15 - 3.30
Weedon	The Stores	3.35 - 4.05
Coppice	Coppice Way	4.15 - 4.30

* Weekly stops from 3rd Jan.95

Jan. 3, 17, 31	Feb. 14, 28	Mar. 14, 28	April 11, 25
May 9, 20	Jun. 6, 20	Jul. 4, 18	Aug. 1, 15, 29
Sept. 12, 26	Oct. 10, 24	Nov. 7, 21	Dec. 5, 19



County Library

All enquiries concerning this service
to be made to;-

AYLESBURY CENTRAL LIBRARY SERVICE
Walton Street,
Aylesbury, HP20 1UU
Tel. 0296 382248

HAZEL FINCH

TOM BECKET

MR BENNIN IRV MACKAY

NATALIE HIGGS

MRS DEBENHURST MRS SHARP

MRS KENT

JACKIE SMITH

IVY HARWOOD

BERNARD OSBORN

COLIN HIGGS

VIC SCOTT

JAY SIMMS

MRS BRANDON

BETTY CLARKE



NORMAN HINDS

BERNARD OSBORN

GEORGE GEMMAN

VIC SCOTT

CHRIS BRANDON

MRS BRANDON

ERIC GREGORY

PAT STEVENS

BOB HIGGS

MRS COLEMAN

TOM BECKET

MR + MRS UNDERWOOD

MRS MINNIT

JOHN FORD
CLARRIE SPIKE

MR FORD

ESMER KENT

MRS MCCUMBER

MRS KELLEHER

? GROOM - ABBEY

BETTY CLARKE

NATALIE HIGGS

HAZEL FINCH

FREDA JENNINGS

RITA FINCH

IVY HARWOOD



JANET BRANDON

COLIN HIGGS

SHEILA BRANDON

FAYTIVE SPIKE

1952 or 1953

ASTON ABBOTTS CHURCH ROOM

AVAILABLE FOR WEDDING RECEPTIONS: BIRTHDAY
PARTIES: FOLK EVENINGS: DANCES: BINGO ETC...

MAXIMUM 60 PEOPLE.

FURTHER DETAILS FROM DORIS SCUTCHINGS ON
AYLESBURY 681243

COST: £2.50 per hour + metered electricity.
£1.50 per hour + metered electricity
for residents of the parish.

Alison J. Whittaker, B.A. Hons. Music
*Piano, Electric Keyboard &
Theory of Music Teacher*

10 Recreation Ground Cottages
Wingrave
Nr. Aylesbury
Bucks. HP22 4PH

Tel: (0296) 681639

Aylesbury 681242

Aylesbury 681425

BIGNELL & BRANDON

CARPENTRY, GLAZING & GENERAL BUILDING

109 WINSLOW ROAD
WINGRAVE
AYLESBURY

12 BRICSTOCK
ASTON ABBOTTS
AYLESBURY

FLACKWELL ELECTRONICS

TV, VIDEO & SATELLITE SERVICING

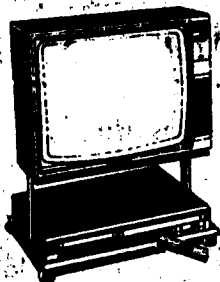

**MOST MAKES REPAIRED
SAME DAY
IN YOUR OWN HOME
20 YEARS EXPERIENCE
ALL WORK GUARANTEED**

AYLESBURY (0296) 682126

Church Farm Aston Abbots
Near Aylesbury
Bucks HP22 4NB

FLACKWELL ELECTRONICS

General Repairs
Rentals, New and Used Sales

No call out fee
within Aston Abotts

Phone David Lewis
682126